

LIQUID RING SELF PRIMING ELECTRIC PUMPS

Instructions for use and maintenance

Ver.:10.02.03

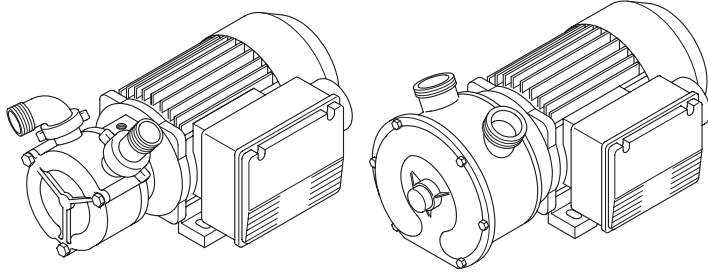

PRELIMINARY WARNINGS

ATTENTION! - Read every part of this manual carefully before using the pump.

ATTENTION! - Before using the pump please check it has not been damaged during transportation; breaks or crashes could compromise the right working of the pump.

ATTENTION! - Even if it is a simple machine, keep children and non authorized personnel away.

ATTENTION! - Please keep this manual carefully and available to all operators.

SPECIFICATIONS FOR DISMANTLING - The pump is made of the following materials: bronze and/or stainless steel, rubber, plastics, aluminium and electric materials. The disposal of the above mentioned materials must be in accordance with the specifications in force (2002/96/CE etc.).



DESCRIPTION AND APPLICATION - Liquid ring pumps, selfpriming (up to 6 meters) and reversible, suitable for the transfer of clear liquids, without any solid parts, with max viscosity of 100 cP. The pumps are made of stainless steel AISI 316 or Bronze. According to the construction material the pumps find good applications in several fields: oenological field and food processing (wine, must, vinegar, oil, fruit juice, bier, sirups and brine), dairy field (milk, whey, etc.), chemical field (acids, solvents, photographic liquids, cleaning products, ink, etc.), agriculture field (anticrotopagams, liquid fertilizers, gas oil, etc.), nautic field (sea water, sweet water, gas oil, etc.). In case of doubts on the product to be transferred please contact the distributor or the producer directly.



ATTENTION! - Do not use the pump in submersion.

ATTENTION! - Do not use the pumps with inflammable liquids or in explosive environment.

IDENTIFICATION - On each pump there is a label showing all identification data of the manufacturer, the code and the main features of the product (model, motor type, fitting type, etc.).

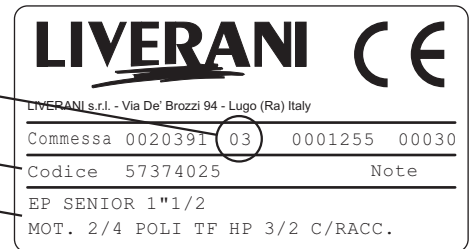

Construction year
Product code
Product description

TECHNICAL FEATURES AND PERFORMANCES - The values stated in the table are approximate and refer to laboratory tests performed with water at 20 °C temperature. The head and the capacity decrease when the viscosity of the product increases.

Type	Pump material	Standard inlet-outlet (*)	Weight (kg)	Motor (**)	RPM	Head max (m)	Capacity max (l/min)
EPH 20	Bronze	Ø20	5.5	MF	2800	15	29
EPH 25	Bronze	Ø25	9.2	MF	2800	18	60
EP 20	Bronze	Ø20	5.7	CC	2000	10	25
			5.7	MF-TF	2800	15	29
EP 25	Bronze	Ø25	9.5	CC	2000	12	53
			9.5	MF-TF	2800	18	60
EP 30	Bronze	Ø30	13.4	CC	1400	18	75
			13.2	MF-TF	1400	18	75
EP 40	Bronze	Ø40	20.4	CC	1400	22	120
			18.0	MF-TF	1400	22	120
EP 50	Bronze	Ø50	27.2	MF-TF	1400	30	230
EP 70	Bronze	BSP-F 2"1/2	75.0	TF	1400	40	500
EP NEOS 3/4"	AISI 316	BSP-M 3/4"	5.1	MF-TF	2800	22	29
EP JUNIOR 1"1/4	AISI 316	BSP-M 1"1/4	9.3	CC	2000	10	43
			9.6	MF-TF	2800	22	58
EP SENIOR 1"1/2	AISI 316	BSP-M 1"1/2	20.0	CC	1400	22	120
			17.6	MF-TF	1400	22	120
EP MASTER 2"	AISI 316	BSP-M 2"	27.0	MF-TF	1400	30	230
EP 70 Inox	AISI 316	BSP-F 2"1/2	75.0	TF	1400	40	500

(*) Ø = dimension outlet pipe fittings (mm)

(*) BSP = inlet-outlet gas (F = inside / M = external)

(**) MF = single phase / TF = three phase / CC = direct current

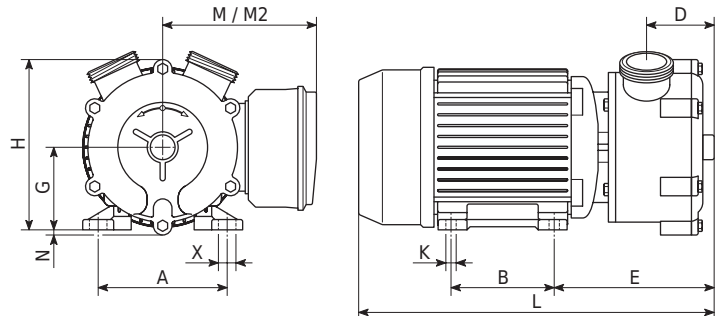

Type	Mot.	Dimensions (mm)											
		A	B	D	E	G	H	K	L	M	M2	N	X
EPH 20	MF	90	71	35	110	56	100	5.5	251	110	-	-	8
EPH 25	MF	112	90	40	130	71	124	7	308	125	-	-	11
EP 20	CC	100	80	35	115	63	106	7	295	-	110	-	12
	MF-TF	90	71	35	110	56	100	5.5	251	135	100	-	8
EP 25	CC	112	90	40	127	71	124	8	320	-	110	-	12
	MF-TF	112	90	40	130	71	124	7	308	145	118	-	11
EP 30	CC	125	100	50	140	80	165	8	375	-	125	5	16
	MF-TF	125	100	50	140	80	165	10	330	155	125	5	17.5
EP 40	CC	140	125	67	180	90	165	10	490	-	130	-	17.5
	MF-TF	125	100	67	162	80	165	10	352	155	125	5	17.5
EP 50	MF-TF	140	125	90	180	90	175	10	435	160	130	12	17.5
EP NEOS 3/4"	MF-TF	90	71	34	107	56	113	5.5	251	135	100	-	12
EP JUNIOR 1"1/4	CC	112	90	50	168	71	137	8	360	-	110	-	12
	MF-TF	112	90	50	168	71	137	8	336	145	110	-	12
EP SENIOR 1"1/2	CC	140	125	76	190	90	165	10	500	-	130	-	17.5
	MF-TF	125	100	76	170	80	165	10	360	155	125	-	17.5
EP MASTER 2"	MF-TF	140	125	94	215	90	193	10	440	160	130	-	17.5

M = on-off reverse switch-capacitor box / M2 = terminal board connection

EP 70 / EP 70 Inox

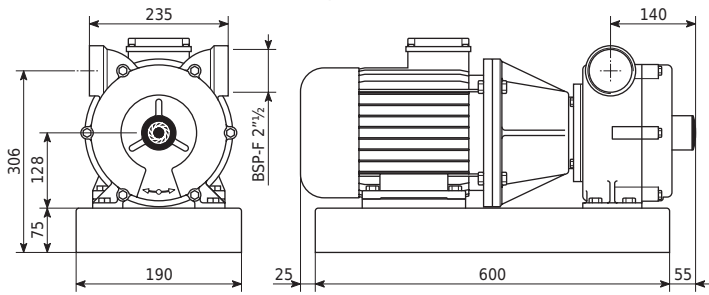

TRANSPORT - The pump can be transported by using the available devices (handle or trolley). For mounting see the pictures below.

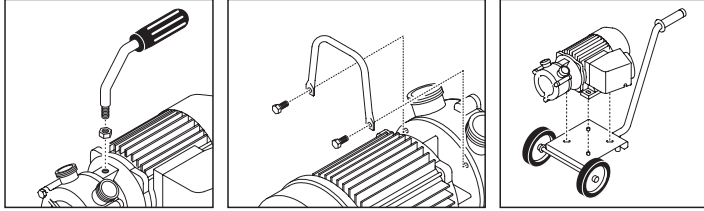

SUCTION - The running direction of the pump determines the inlet and the outlet hole. The pump can work in both directions and therefore a direction change and the reversing of it is always possible, even during the working operation (for example in case of exceeded liquid or emptying a piping circuit). We suggest to use short inlet pipes for an easy self priming intake (automatic suction).

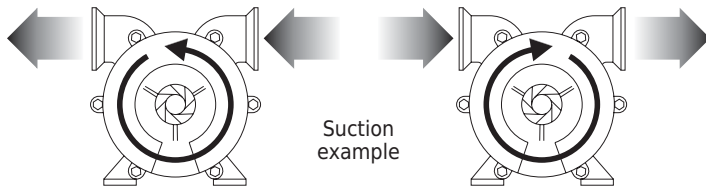

PUMP WORKING - Before working start, pour into the body pump some of the liquid to be transferred (see table below). This must be done to get the priming, that is the suction of the fluid, automatically carried out by the pump while it is working. Later, start the pump; priming requires only a few seconds. If the pump does not prime after 10/15 seconds, check if the suction hose has any leakage of air, maybe due to holes or to poor tightening of the collar or of the hose-clamps. When the working is completed, stop the pump and clean it.

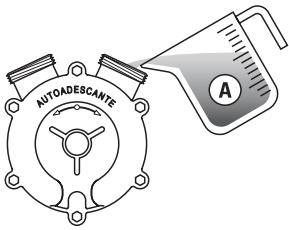

Type	A (liters)
EPH-EP 20 / EP NEOS 3/4"	~ 0,20
EPH-EP 25 / EP JUNIOR 1"1/4	~ 0,40
EP 30	~ 1,20
EP 40 / EP SENIOR 1"1/2	~ 1,50
EP 50 / EP MASTER 2"	~ 2,00
EP 70 / EP 70 Inox	~ 4,00

PUMPS WITH BY-PASS - The bypass valve connects the inlet and outlet pipe of the pump. When necessary it is possible to open the valve to decrease the capacity and the head of the pump according to requirements. In order to have the self priming action at the beginning of the working, the bypass valve must be completely closed.

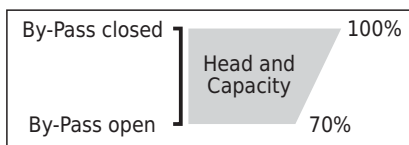
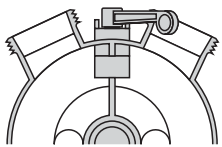

CLEANING - The pump must be cleaned after the working time, in order to preserve the mechanical and sanitary features. For internal cleaning, operate the pump for a 1-2 minutes using clean water or compatible detergent with bronze or stainless steel AISI 316.



ATTENTION! - When cleaning the pump do not use aggressive products or non compatible with bronze or stainless steel AISI 316 and do not throw bolt of water to the electric components (control panels, electric motors, etc.).

INSTALLATION - The pump must not be moved while it is working and it must be horizontal to the ground. The pump can be fixed using the holes on the support. The level of the product to be transferred must be at a maximum depth of 6 m from the pump axis. The head determines the capacity; the higher is the head the lower the capacity will be.

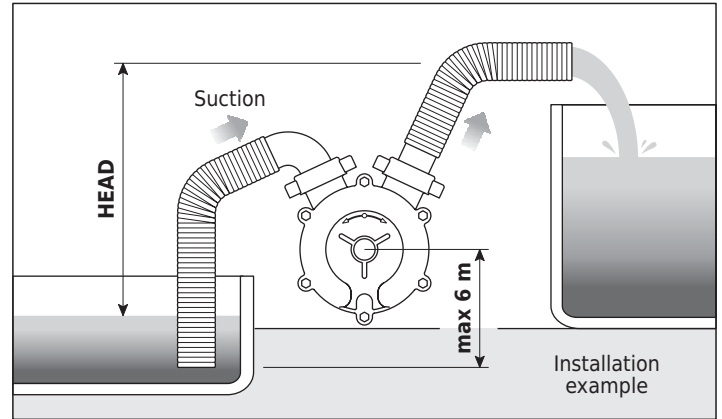

ELECTRIC CONNECTIONS - The pumps without electric plug (excluded EPH type) must be connected to the feeding source using the exit cables or the terminal board connections. The technical data for the electric connections are stated on the name plate on each electric motor. Further information (special connections, etc.) are stated near the terminal board or the control panel.



ATTENTION! - The electric connection and any other intervention on the control panel of the pump must be performed by qualified and specialized staff only according to the CE standards; most important, the control panel must be equipped with an adequate earthing. All electric features of the pump must be the proper ones and in accordance to those of the panel to which it will be connected.

MAINTENANCE - Each pump is adjusted and tested inside the factory during and after the assembling of it. Very few maintenance interventions are required depending on the wear and tear of the pump caused mainly by the pressure and by the kind of fluid to be transferred. Leaks from the body of the pump suggest that the sealings and/or the mechanical seal are worn out and must be replaced.



ATTENTION! - Before doing any maintenance or repair operation disconnect the electric feeding.
ATTENTION! - Any maintenance or repair operation must be performed by specialized and authorized staff and all spare parts must be original. Do not try any emergency repairer intervention which could compromise the right working of the pump.

DECLARATION OF COMPLIANCE

MODEL-TYPE: EPH-EP 20, EPH-EP 25, EPH-EP NEOS 3/4", EP NEOS 3/4" T, EP 30, EP 40, EP 50, EP 70, EP JUNIOR 1"1/4, EP SENIOR 1"1/2, EP MASTER 2", EP 70 Inox.

DESCRIPTION: Pump for transferring liquids not inflammable or explosive. Type EP JUNIOR 1"1/4, EP SENIOR 1"1/2, EP MASTER 2", EP 70 Inox, suitable for alimentary uses.

We, the undersigned, under our exclusive responsibility declare that the above mentioned machine is in compliance with the Directives 2006/42/CE, 89/336/CE (EMC), 2002/95/CE (RoHS). It is highly forbidden to operate the above mentioned component before the machine in which it has to be assembled has been declared "in compliance with the standards" laid down by the directive 2006/42/CE, 89/336/CE (EMC), 2002/95/CE (RoHS).

Lugo 01.01.2010

Francesco Bertozzi (Managing Director)

LIVERANI s.r.l. - Via De' Brozzi, 94 - 48022 Lugo (RA) ITALY
TEL. ++39 0545 22379 - FAX ++39 0545 30350
<http://www.liverani.com> e-mail: liverani@liverani.com